

叠加式温度补偿调速阀和单向调速阀

Pressure and Temperature Compensated Flow Control (and Check) Modular Valves

参数

型号	最高工作压力 MPa	压力调节范围 MPa	最大流量 L/min
MFP-03-11	16	50	—
MF※-03-※-11			70

型号说明

MFA	-03	-X	-11
系列号	规格	控制方向	设计号
MFP : P油路用 叠加式调速阀	03	—	11
MFA : A油路用 MFB : B油路用 MFW : A、B油路用 } 叠加式单向调速阀		X: 出口节流用 Y: 进口节流用	11

使用注意事项

- 进行流量调节时，先松开刻度盘锁紧螺母，向逆时针方向旋转，流量增加。调节后，必须拧紧刻度盘螺钉。

特性 油液：粘度35mm²/s，比重0.850

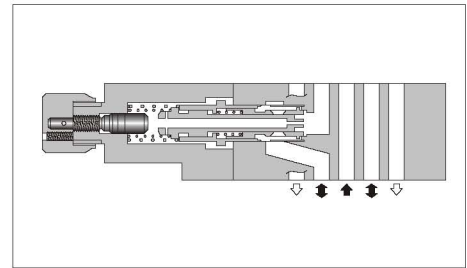
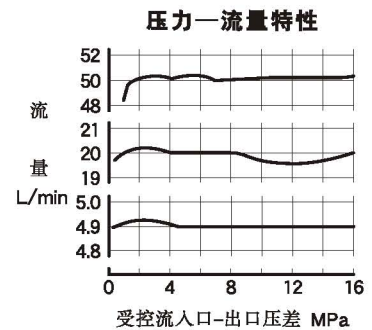
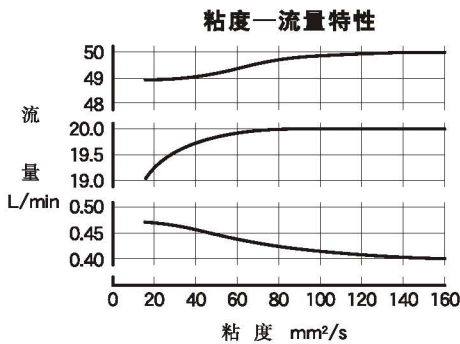
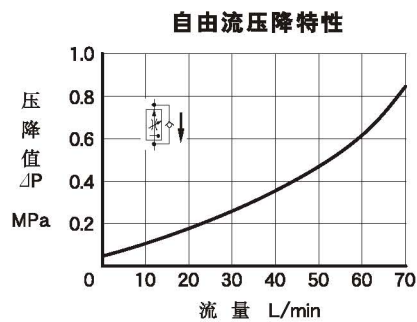
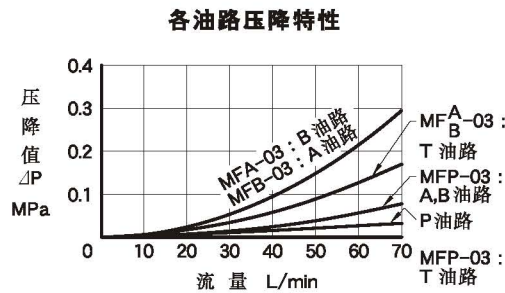
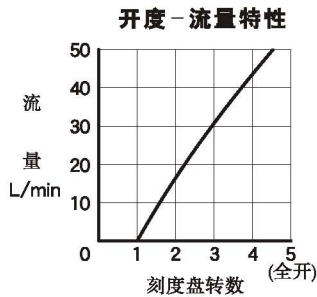
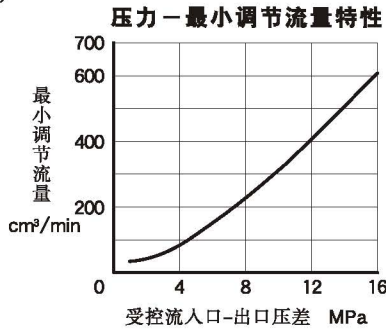
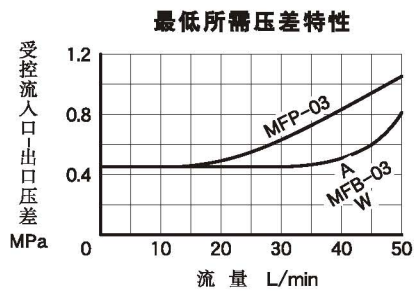

型号	JIS液压图形符号	详细液压图形符号
----	-----------	----------

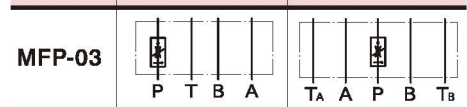

型号	出口节流
----	------

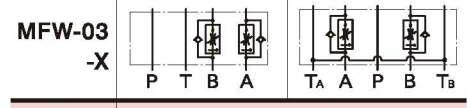
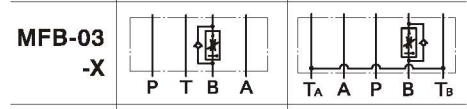
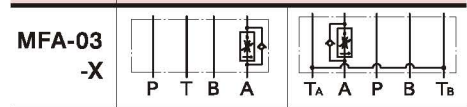

型号	进口节流
----	------

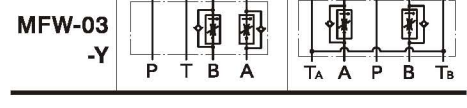
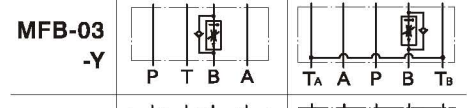
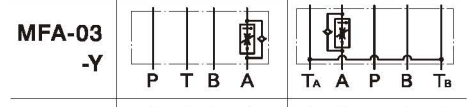

MFP-03

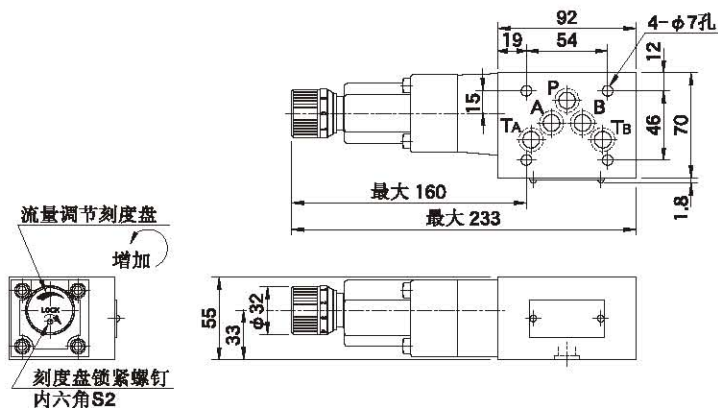

质量……约4.2kg

MFW-03-X Y

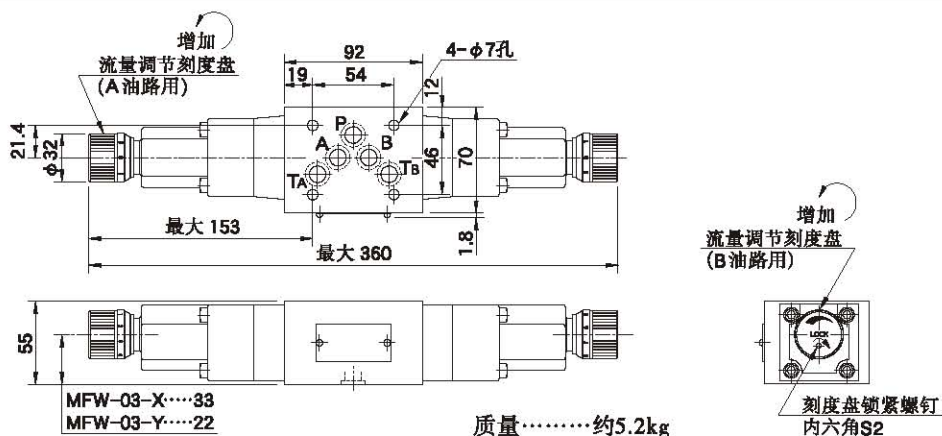

质量……约5.2kg

MFA-03-X Y

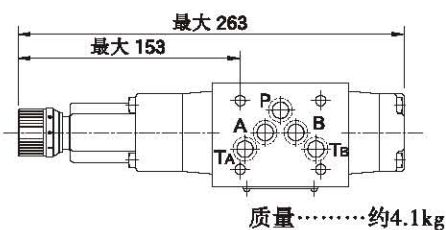

质量……约4.1kg

MFB-03-X Y

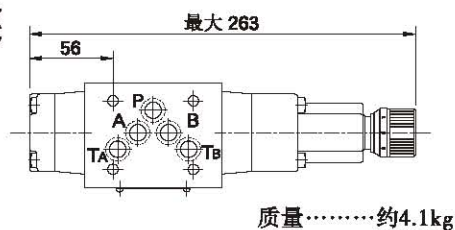

质量……约4.1kg

其余尺寸请参见上图(MFW-03)。

■ 密封件表

MFP-03
MFA-03
MFB-03
MFW-03

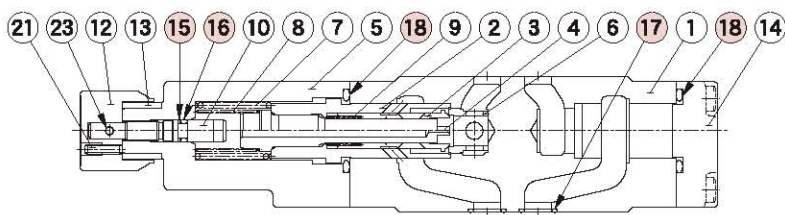

MFA-03

- MFP-03型, 阀体①不同。
- MFB-03型, 流量调节部分装在右侧。
- MFW-03型, 流量调节部分装在左右两侧。

序号	零件名称	零件号	数量			
			MFP-03	MFA-03	MFB-03	MFW-03
15	挡圈	JIS B 2407-T2-P6	1	1	1	2
16	O形圈	JIS B 2401-1A-P6	1	1	1	2
17	O形圈	AS568-014 (NBR, Hs90)	5	5	5	5
18	O形圈	JIS B 2401-1B-P28	1	2	2	2

F

03 系列叠加阀